

ANCRAGE DU VEHICULE
ANCHORING OF THE VEHICLE
VERANKERUNG DES FAHRZEUGS
ANCORAGGIO DEL VEICOLO
ANCLAJE DEL VEHICULO

AN.27.B + AN27.03
Ou/Or/Oder/O
AN.34
Ou/Or/Oder/O
AN.34.S

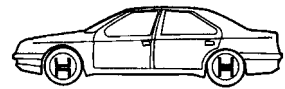

**M8S
MT10
SVN**

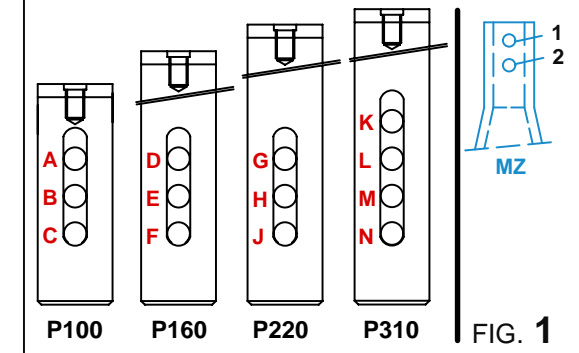
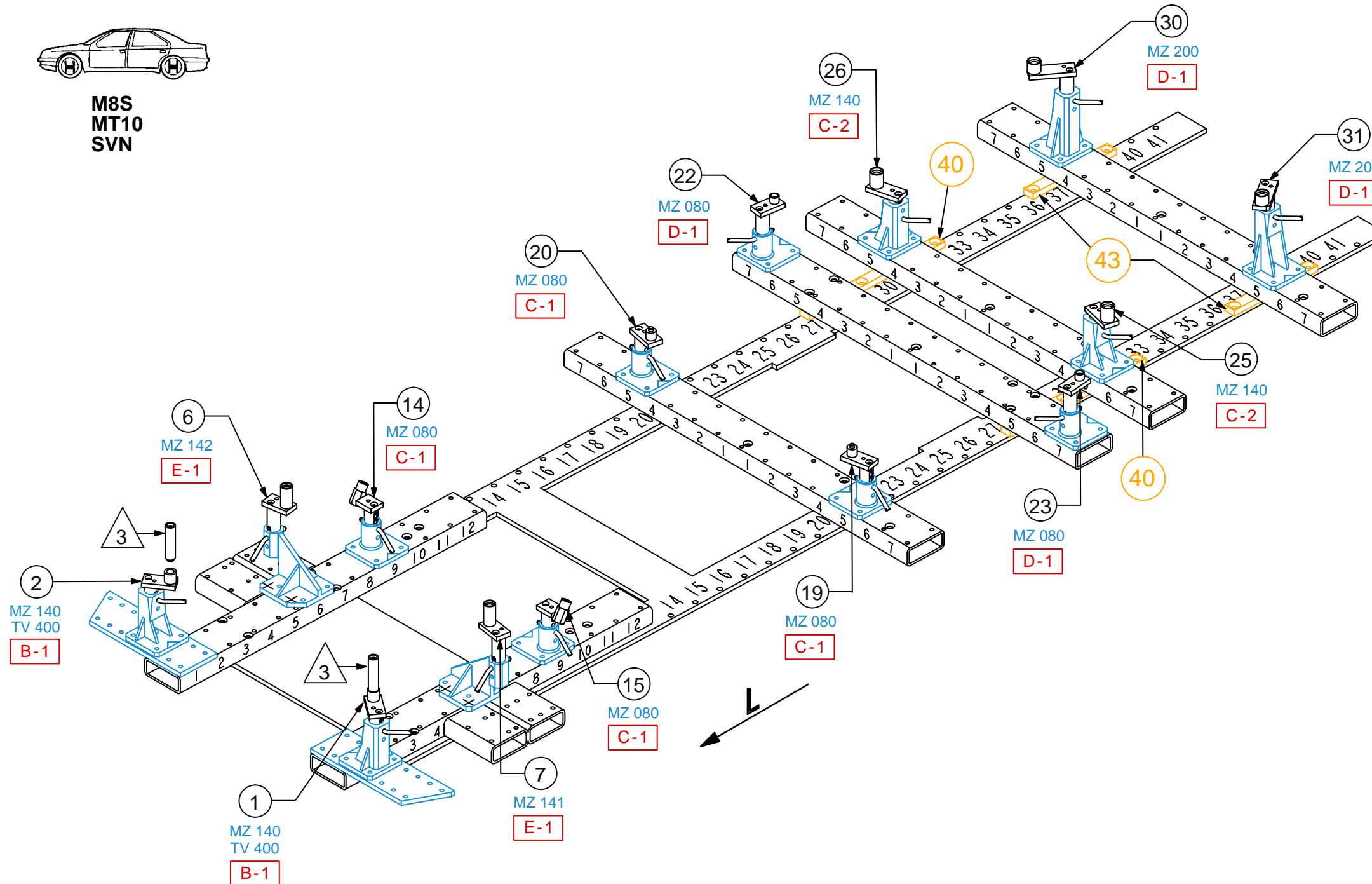

REP.	REFERENCE	NB	PDS	KEY	SYMBOL
38	2551.5038	1	1,0	M12x1,50-70	
39	2551.5039	1	1,0		
40	2551.5040	2	3,3	955714 TFHc 16-60	
41	2551.5041	1	1,7	(M12-30)	
42	2551.5042	1	1,7		
	D.073	2	0,5		
43	2551.5043	2	2,0	955714 TFHc 16-60	
44	2551.5044	1	1,4	M10-30	
45	2551.5045	1	1,7		
46	2551.5046	1	1,7		
	M 10-30	2			
	M 12-30	2			
	M 12x1,50-70	2			
	955714	12			
	TFHc 16-60	8			

complément au
complementary set to
complemento al
zusatz zu **2551.500**

2551.507

26 Kg	07.01.2011	406-D-31Q
2551.507-RVA3-1		00

○ □ △ Voir texte
Vedere testo
Siehe Text
See text
Ver instrucciones

BMW



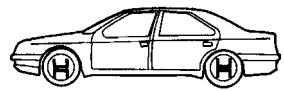

**M8S
MT10
SVN**

ANCRAGE DU VEHICULE
ANCHORING OF THE VEHICLE
VERANKERUNG DES FAHRZEUGS
ANCORAGGIO DEL VEICOLO
ANCLAJE DEL VEHICULO

AN.27.B + AN.27.03
Ou/Or/Oder/O
AN.34
Ou/Or/Oder/O
AN.34.S

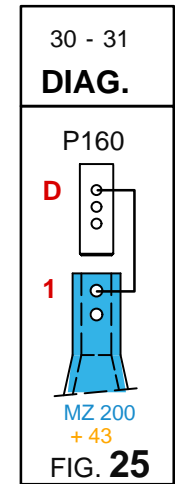
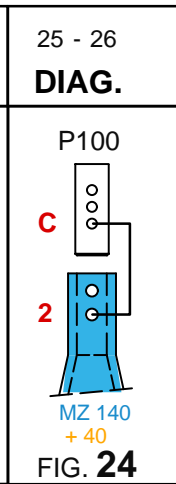
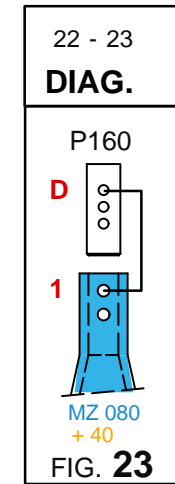
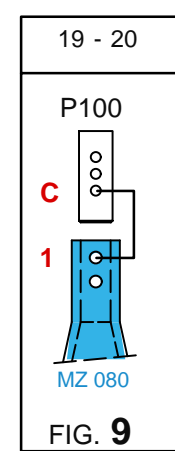
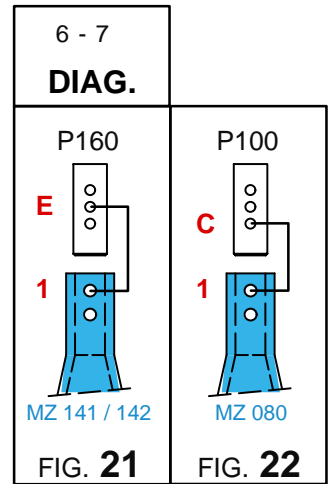
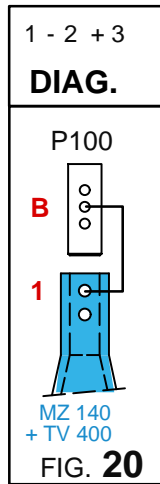
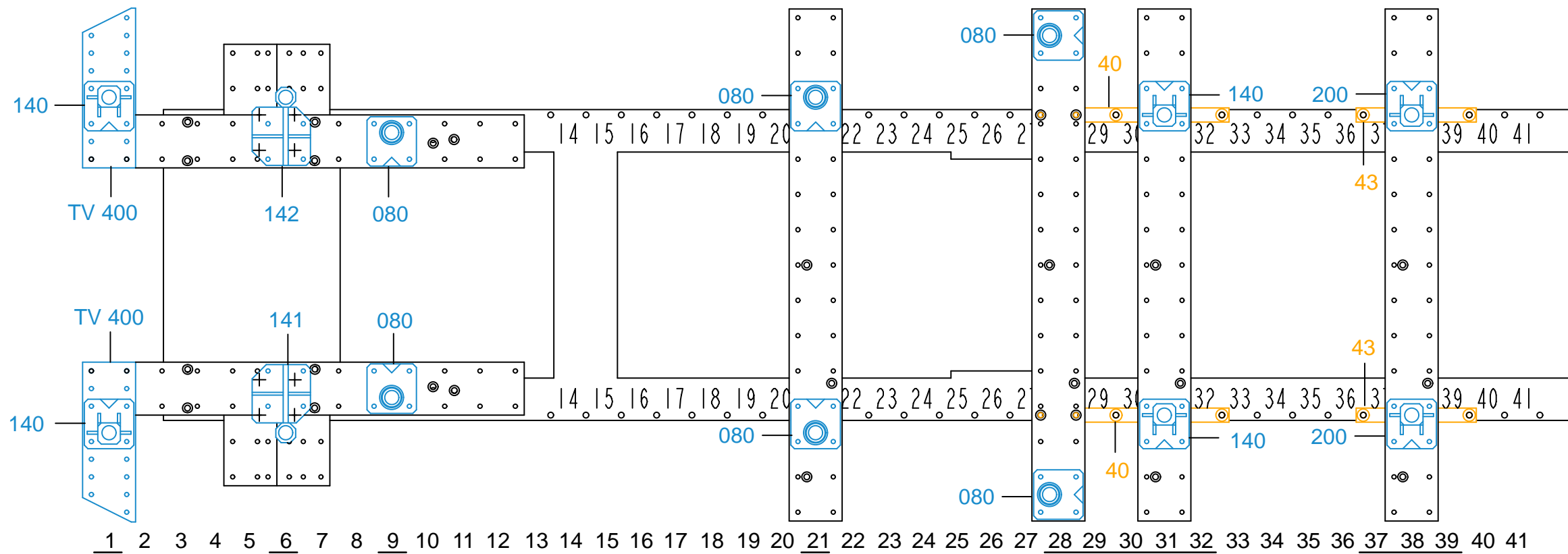

○ □ △ Voir texte
Vedere testo
Siehe Text
See text
Ver instrucciones

BMW

2551.507		
26 Kg	07.01.2011	406-D-31S
2551.507-RVA3-2		00